



Supplier Packaging Manual North America

*** For all suppliers (domestic or international) shipping to AGCO North America sites**

UPDATED: Jun 2022

Table of Contents

1 General.....	3
1.1 Packaging Manual purpose.....	3
2 Package Type.....	3
2.1 Selection of Package Type.....	3
2.2 Package Type for Manufacturing “Production Parts”.....	3
2.3 Package Type for “Service Parts”.....	3
3 General Packaging Requirements.....	4
3.1 Basic Protection Requirements.....	4
3.1.1 Shock & Vibration.....	4
3.1.2 Crushing Protection.....	4
3.1.3 Scuff Protection.....	4
3.1.4 Labels and Tape on Painted Part Surfaces	4
3.1.5 Moisture Protection	4
3.1.6 Contamination & Cleanliness Production.....	4
3.1.7 Loss of Small Parts & Packages.....	4
3.1.8 Corrosion Protection.....	4
3.2 Standardization, Size, and Consistency	5
3.3 Reusable or Returnable Packaging.....	5
3.4 Lumber & Wood Packaging Materials	5
3.5 Securing of Loads (Unitization)	6
3.6 Corrugated Fiberboard Packaging Materials	6
3.7 Internal Packaging	7
3.8 Stacking.....	8
4 Packaging Label Requirements.....	8
4.1 Pallet and Shipping Container Identification	8
4.2 Primary and Secondary Label	9
4.3 Label Specifications	12
4.4 PPAP Samples	12
4.5 Recycling Marks	13
4.6 Handling Instructions	13
5 Regulatory and Environmental Requirements.....	15
5.1 Regulatory Requirements	15
5.2 Restricted Materials	15
6 Packaging Proposals and Approval.....	16

1 General Information

The definitions and specifications described here for the supply of parts to AGCO NA sites form the basis of our conditions of business and are valid as additional contractual agreements supplementing our general purchasing conditions.

1.1 Packaging Manual Purpose

This packaging manual intends to impart the AGCO Corporation packaging requirements in partnership with the suppliers concerned. This packaging manual applies to all suppliers supporting AGCO NA sites. The following regulations are required to guarantee a rational and undisturbed flow of material between suppliers and AGCO NA sites regarding:

- Efficient and cost effective packaging design
- Standardized dimensions for corrugate boxes, wood pallets, wood crates and other transportation packaging
- Damage free protection of the parts
- Agreed contents quantities per packaging unit
- Appropriate and clear labeling information

The supplier must fulfill the following requirements regardless of the selected type of packaging:

- The parts must be free from all contamination (mechanical damage and chemical damage)
- Optimal efficiency of the pallet or unit load
- Handling-suitable parts removal
- Stack-ability (warehouse and transportation)
- Recyclable materials preferably
- Preferred use of returnable packaging
- Minimized use of one-way packaging
- When shipping via small package air carriers, the individual packages may not exceed a weight of 70kg/150lbs.

Please contact the Logistics Packaging Department if any area of this manual requires further clarification or explanation. Correspondence should be directed to AGCONAPackaging@AGCOcorp.com

2 Package Type

2.1 Selection of Package Type

Parts should be packaged in accordance with standards listed in the AGCO packaging manual. All sourced package material must arrive damage-free with full integrity to the receiving point.

2.2 Package Type for Manufacturing “Production Parts”

“Line use parts” or “ASM parts” is preferred to be shipped in reusable or returnable packaging when possible.

Use reusable or returnable packaging whenever cost of the packaging and the return transportation is justified. AGCO Sourcing Leaders will provide guidance to select or design returnable packaging and assure return to the supplier.

Multipack line use parts whenever possible to minimize packaging material cost and waste.

Do not use individual packages for line use parts except when the size, weight, fragility of the part do not allow multipack.

2.3 Package Type for “Service Parts”

Unless otherwise specified, always ship “service parts” in individual packages. If applicable, reusable or returnable packaging can be used, but their usage will most likely be between AGCO NA sites only and expendable packaging solution for one-way delivery be used for final customer shipment.

Service parts will be shipped individually between AGCO NA sites and customer sites, and could be unpackaged and repackaged multiple times. All packages must be capable of multiple shipments and multiple openings and closings.

3 General Packaging Requirements

3.1 Basic Protection Requirements

3.1.1 Shock & Vibration

Provide adequate cushioning and dunnage materials to prevent damage from shock and vibration during shipment. The amount of protection required depends upon the fragility of the parts and varies by the protective materials and mode of transport used. Cushion small parts within their packages. Medium and large parts can be protected with cushioned wood bases or special isolation systems built into the part itself.

3.1.2 Crushing Protection

Provide adequate compression strength with the package and or product to prevent crushing during anticipated distribution and storage stacking and handling conditions. Some package crushing is acceptable as long as there is no part damage or loss of package integrity, but it should be minimized.

3.1.3 Scuff Protection

Use scuff resistant materials to protect all painted, plastic, and other finished part surfaces that come into contact with wood, untreated corrugated fiberboard, other products, or anything that could potentially damage the surface.

3.1.4 Labels and Tape on Painted Part Surfaces

Do not apply labels or tape to exposed part surfaces unless the adhesive used are specifically designed to not harm the surface, or have been tested and confirmed to release cleanly and not harm the surface. Consideration must be given to the length of time anticipated before removal due to adhesive hardening and bonding overtime.

3.1.5 Moisture Protection

Moisture protection requirements apply when such conditions (rain or heavy condensation, high humidity, standing water, and rapid temperature changes) may be encountered during distribution. In a controlled system when rain, standing water, or similar extreme conditions are avoided (i.e. direct shipment from part supplier to a manufacturing facility in a dedicated transport vehicle, small package shipping by express carrier, etc.), water resistant materials may not be required. The "international suppliers" must make this judgement based on knowledge of the distribution system being used and the needs of the parts.

3.1.6 Contamination & Cleanliness Protection

Cover large parts that ship loose on wood skids with plastic bags or other acceptable coverings to keep them clean during distribution. Bag or wrap smaller parts that are susceptible to contamination to keep them free from contaminants, including dust from cushioning and dunnage materials.

3.1.7 Loss of Small Parts & Packages

Consolidate very small parts with other parts and packing materials to prevent loss and or misplacement. Label or mark packages properly.

3.1.8 Corrosion Protection

Provide protection for parts that are susceptible to corrosion. Typical methods of protection include:

Metal Coating & Finishes – metal surfaces that are susceptible to corrosion should be finished, painted, or coated in some way to provide permanent protection.

Contact Preservatives – temporary corrosion prevention can be applied directly to metal surfaces.

Part Surfaces in Contact with Wood – finished and unfinished part surfaces should not be in prolonged direct contact with wooden packaging. Moisture barrier materials must be used to isolate parts from all wooden packaging surfaces or components such as crates, blocking or pallets.

Humidity & Moisture Control – vapor barrier materials must completely surround the part and be sealed to prevent moist air from coming in contact with the part. Desiccant must always be used with sealed systems to absorb moisture that is inside the vapor barrier materials.

- **Barrier Materials & Desiccant**
- **Vacuum Pack**
- **Vapor Corrosion Inhibitors (VCI)**

3.2 Standardization, Size, and Consistency

Minimize the number of different packaging sizes and other packaging materials used.

Parts should be packaged consistently, maintaining the same quantity (standard packing quantity), orientation, and container type. This will eliminate and avoid confusion on the receiving end.

Select packages that allow tolerable space for cushioning and dunnage material, but minimize unnecessary space in order to maintain the overall package size as small and compact as possible.

Important note: For all air freight shipments, a packing list must be placed inside **AND** outside of the carton or package.

3.3 Reusable or Returnable Packaging

- Utilize reusable packaging when mutually acceptable between shipper and receiver.
- AGCO NA site will design and own the reusable or returnable packaging.
- “Supplier owned” reusable or returnable packaging should not be shipped directly to AGCO NA site unless a return system in place. Please e-mail AGCONAPackaging@AGCOcorp.com to request the return system.
- Reusable or returnable packaging should be labeled and marked properly.

3.4 Lumber & Wood Packaging Materials

3.4.1 Conformance

All wood pallets and other packaging material comprised of wood must conform to International Standards for Phytosanitary Measures No. 15 (ISPM #15), Guidelines for Regulating Wood Packaging Material in International Trade. More information can be found at www.ippc.int or www.nappo.org.

3.4.2 Wood Packaging Specifications

Use only four-way entry, double-face, non-reversible pallets.
Wings pallets are not acceptable.
No overhang of product material is allowed.
Pallet loads must not exceed 2500 pounds.



3.5 Securing of Loads (Unitization)

Use break-resistant strapping for crate and package reinforcement, carton closure, securement, unitizing, bundling, bracing, palletizing, and other applications. Use adequate corner protectors, cushioning, etc. as required to insure package integrity and product protection. The use of plastic or plastic cord strapping is preferred. Metal strapping has sharp corners and edges that can cause injury and can be difficult to dispose of at our sites. All loads over 68kg (150 lbs.) must be strapped on all sides (i.e. in both directions).

Loads secured to pallets using shrink or stretch-wrap must use material of sufficient thickness to retain the load and to prevent load shift. Use a minimum of 70-gauge (0.0007 inch) stretch wrapping. The stretch wrap can be twisted like rope for greater strength, but only in combination with full stretch wrapping of the load. Securely capture the pallet when wrapping the bottom layer. Wrap the entire pallet load (pallet + product) with a minimum of three times, heavier loads may require more. **DO NOT ONLY WRAP THE CARTONS.**



3.6 Corrugated Fiberboard Packaging Materials

Do not ship corrugated containers or boxes loose domestically and internationally by air or ocean, except under special conditions (i.e. small parcel).

Corrugated containers or boxes must be palletized to ensure part protection and to permit handling with for trucks.

To ensure load integrity, boxes must not overhang the pallet. Boxes must be aligned and fully utilize the length and width of the pallet due to compression strength loss.

Boxes must have a box maker's certificate visible on the assembled container displaying Edge Crush Test (ECT).

Parts plus dunnage should completely fill the box to prevent collapsing because of excessive voids.

Boxes must be adequately sealed to assure they do not open during shipping or handling.

Expendable packaging on paper products, paperboard, fiberboard or similar materials must be designed to withstand an environmental atmosphere of 40 +/- 2°C (104 +/- 4°F) with 85 +/- 5% relative humidity. Suggested pre-condition environment considers a temperature of 23 +/- 1°C (73 +/- 2°F) with a 50 +/- 2% relative humidity. Refer to ASTM D685 – Standard Practice for Conditioning Paper and Paper Products for Testing, and ASTM D4332 – Standard Practice for Conditioning Containers, Packages or Packing Components for Testing.

Multiple corrugated boxes on a wood base example



Small package consolidation in large corrugated box and in wood box example

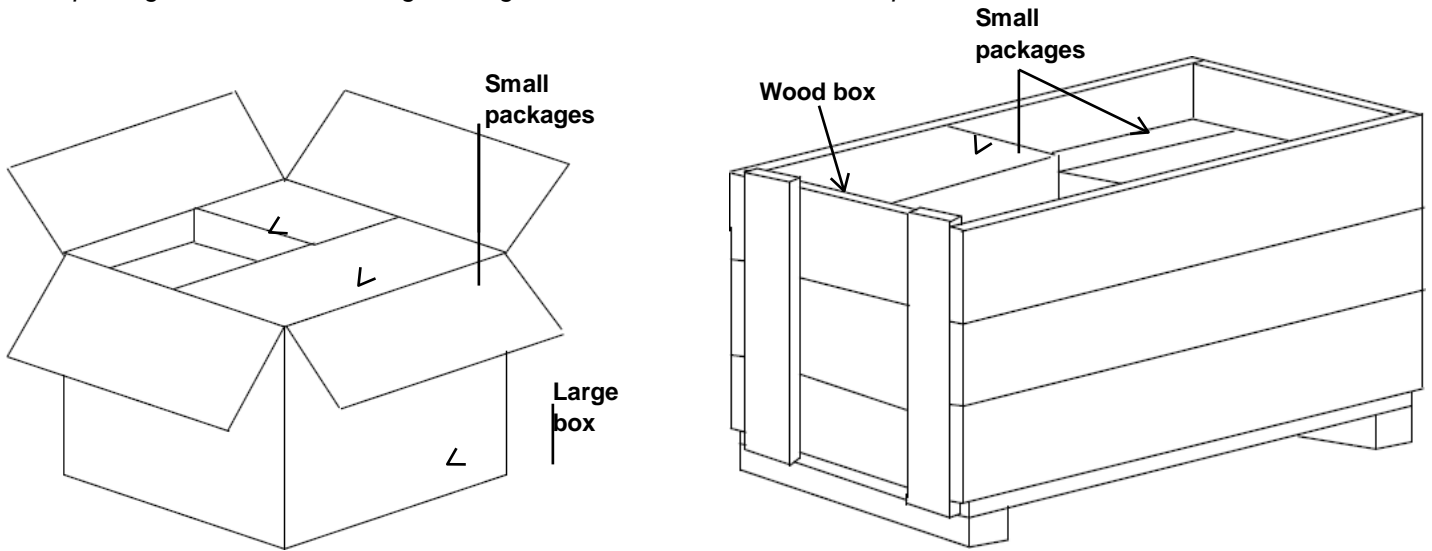

3.7 Internal Packaging

All purchased parts must be packed and secured to prevent breakage or leakage and to control movement within the outer package. For reason relating to part protection or handling, internal packaging is required for a range of packaging applications and transportation modes. Internal packaging (dunnage) can be used in both returnable and expendable packaging.

Expendable internal packaging example



Decisions as to the necessity for internal packaging (dunnage), its development and implementation are the responsibility of the part supplier, although AGCO NA reserves the option to review these matters.

3.8 Stacking



Unit loads must be designed with sufficient strength to allow stacking of like parts up to a height of 228cm (90 inch) for international shipping and 259cm (102 inch) for domestic shipping. This rule does not apply to parts that should not be stacked due to their weight, or the location of their center of gravity. These parts and others with limitations should be clearly marked “DO NOT STACK”, “DO NOT STACK OVER 2 HIGH”, “DO NOT TOP LOAD”, “VERY HEAVY-FLOOR LOAD ONLY”, etc.

Important note: Corrugated boxes will lose up to 50% or more their stacking strength in the humid conditions typically found in ocean containers.







4 Packaging Label Requirements

4.1 Pallet and Shipping Container Identification

AGCO NA suggests the use of NA AIAG standard for general identification. Below is the Shipping Label Standard.

(1) Goods recipient (GR) AGCO Fendt 87616 Marktobendorf	(17) Dock (D) A	(2) Storage location (SL) 123-456	(18) Due date (DD) 2010-05-12	(19) Data matrix 
(3) Delivery note number / ASN (N) 12345678 	(4) Supplier address (SA) BHM			(7) No. of parcels (NP) 3
(8.1) Customer item number (P) 1234567890 	(5) Net weight (NW) 90 kg	(6) Gross weight (GW) 190 kg	(10) Item description/ Shipment designation (ID) AIR FILTER	
(9) Purchase/Production order number (205) 123456 	(8.2) Supplier item number (305) 123ABC			(11) Quantity/Contents (Q) 1 piece 
(12) Supplier number (V) 12345 	(13) Shipping date (SD) 2010-04-12		(14) Change status, design (CS)	
(15) Parcel number/where applicable SSCC (S) 123456789 	(16) Batch number/serial number (H) XXX123XXX 			

4.2 Primary and Secondary Labels









(1) Goods recipient (GR) AGCO Fendt 87616 Marktobendorf	(17) Dock (D) A	(2) Storage location (SL) 123-456	(18) Due date (DD) 2010-05-12	(19) Data matrix 
(3) Delivery note number / ASN (#) 12345678 		(4) Supplier address (SA) BHM		
(8.1) Customer item number (P) 1234567890 		(5) Net weight (NW) 90 kg	(6) Gross weight (GW) 190 kg	(7) No. of parcels (NP) 3
(9) Purchase/Production order number (20 S) 123456 		(10) Item description/ Shipment designation (ID) AIR FILTER		
(12) Supplier number (V) 12345 		(11) Quantity/Contents (Q) 1 piece 		
(15) Parcel number/where applicable SSCC (S) 123456789 		(13) Shipping date (SD) 2010-04-12	(14) Change status, design (CS)	
		(16) Batch number/serial number (H) XXX123XXX 		

Primary label shows 3 containers (#7) with 1 piece each (#11) for both the same part number (#8.1) and the same purchase order (#9).

(1) Goods recipient (GR) AGCO Fendt 87616 Marktobendorf	(17) Dock (D) A	(2) Storage location (SL) 123-456	(18) Due date (DD) 2010-05-12	(19) Data matrix 
(3) Delivery note number / ASN (#) 12345678 		(4) Supplier address (SA) BHM		
(8.1) Customer item number (P) 1234567890 		(5) Net weight (NW) 90 kg	(6) Gross weight (GW) 190 kg	(7) No. of parcels (NP) 3
(9) Purchase/Production order number (20 S) 123456 		(10) Item description/ Shipment designation (ID) AIR FILTER		
(12) Supplier number (V) 12345 		(11) Quantity/Contents (Q) 3 piece 		
(15) Parcel number/where applicable SSCC (S) 123456789 		(13) Shipping date (SD) 2010-04-12	(14) Change status, design (CS)	
		(16) Batch number/serial number (H) XXX123XXX 		

Secondary label consolidates number of pieces (#11) according to the number of containers (#3) packed into the same consolidated package. The secondary label can be read and checked during logistics process without opening consolidated boxes.

Primary and Secondary Label Example

(1) Goods recipient (GR) AGCO Fendt 87616 Marktobendorf	(17) Dock (D) A	(2) Storage location (SL) 123-456	(18) Due date (DD) 2010-05-12	(19) Data matrix 
(3) Delivery note number / ASN #(I) 12345678 	(4) Supplier address (SA) BHM			
(8.1) Customer item number (P) 1234567890 	(9) Net weight (NW) 90 kg	(6) Gross weight (GW) 190 kg	(7) No. of parcels (NP) 3	
(10) Item description/shipment designation (ID) AIR FILTER				
(9) Purchase/Production order number (20 S) 123456 		(8.2) Supplier item number (30 S) 123ABC		
(11) Quantity/Contents (Q) 1 piece 				
(12) Supplier number (V) 12345 	(13) Shipping date (SD) 2010-04-12	(14) Change status, design (C-S)		
(15) Parcel number/where applicable SSCC (S) 123456789 	(16) Batch number/serial number (H) XXX123XXX 			

Primary label on single container

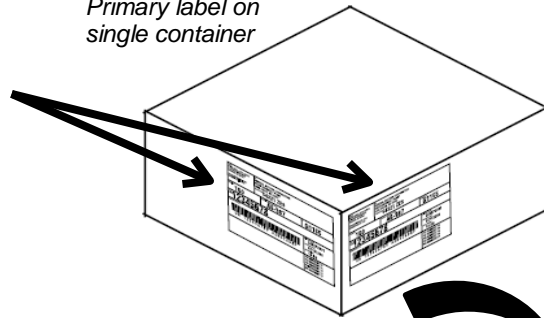

(1) Goods recipient (GR) AGCO Fendt 87616 Marktobendorf	(17) Dock (D) A	(2) Storage location (SL) 123-456	(18) Due date (DD) 2010-05-12	(19) Data matrix 
(3) Delivery note number / ASN #(I) 12345678 	(4) Supplier address (SA) BHM			
(8.1) Customer item number (P) 1234567890 	(9) Net weight (NW) 90 kg	(6) Gross weight (GW) 190 kg	(7) No. of parcels (NP) 3	
(10) Item description/shipment designation (ID) AIR FILTER				
(9) Purchase/Production order number (20 S) 123456 		(8.2) Supplier item number (30 S) 123ABC		
(11) Quantity/Contents (Q) 3 piece 				
(12) Supplier number (V) 12345 	(13) Shipping date (SD) 2010-04-12	(14) Change status, design (C-S)		
(15) Parcel number/where applicable SSCC (S) 123456789 	(16) Batch number/serial number (H) XXX123XXX 			

Secondary label on consolidated package or unit load

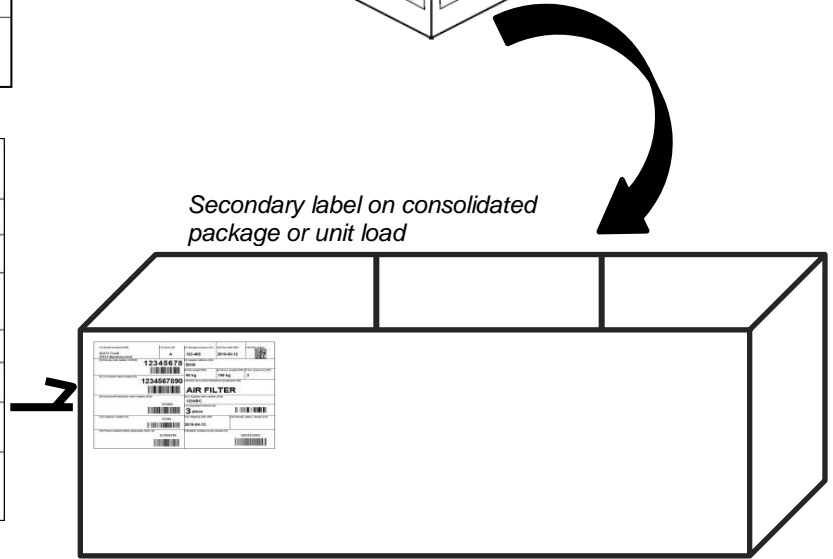

Primary label is placed on each shipping container on one handling unit.

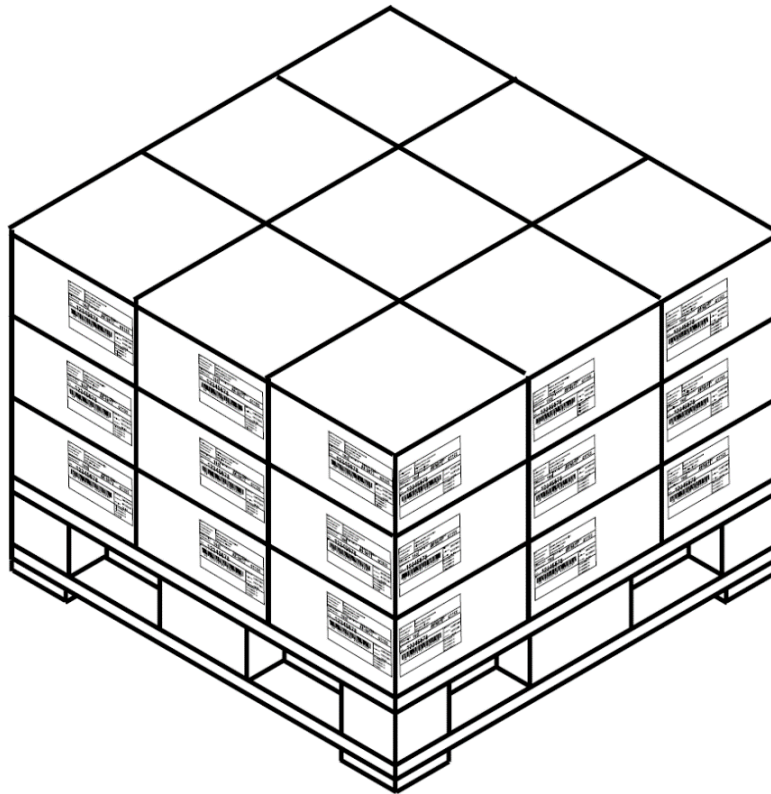

Below is the supplier shipping labels being applied to adjacent side of each shipping container.

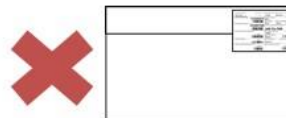
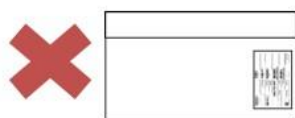
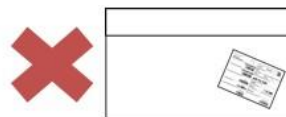

4.3 Label Specifications

Size: 4.0 inch (102mm) high by 6.0 inch (152mm) wide.

White adhesive labels with printing in black ink. The size of the characters must be greater than 1/4" high (6mm).

Method of marking: Handwriting or lettering is not acceptable.

A label should be applied to each shipping container when it contains a single part number per handling unit.

A label should be applied to each shipping container when it contains multiple part numbers per handling unit.

Barcode should be read vertically. Avoid placing shipping labels sideways or diagonally.

DO NOT APPLY LABELS DIRECTLY TO THE RETURNABLE PACKAGING, unless the label's adhesive is classified as "removable" type. The supplier is responsible to remove all old shipping labels.

4.4 PPAP Samples

The following label communicates information about the supplier's name, AGCO part number, PO number, ship date, and revision number, ship to (AGCO site), and part level.

Size: 4.0 inch (102mm) high by 6.0 inch (152mm) wide. Example of PPAP sample label:

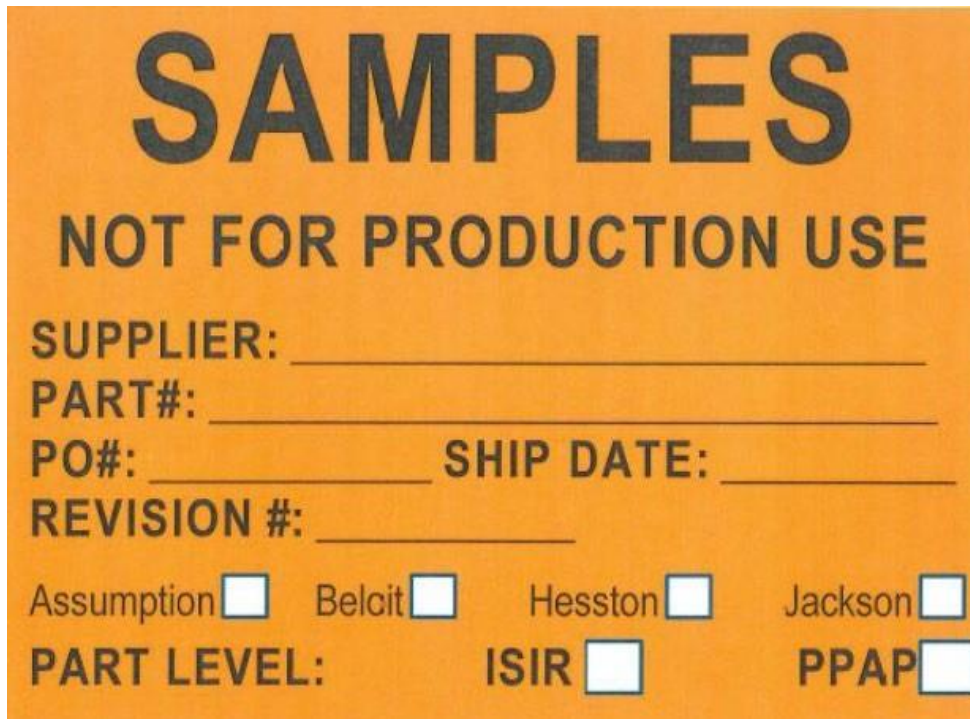

SAMPLES

NOT FOR PRODUCTION USE

SUPPLIER: _____

PART#: _____

PO#: _____ **SHIP DATE:** _____

REVISION #: _____

Assumption Belcit Hesston Jackson

PART LEVEL: ISIR PPAP

4.5 Recycling Marks

4.5.1 Corrugated Fiberboard Packaging

Minimum of one recycling mark per corrugated fiberboard container or box
The recycling marks can be pre-printed on the box or added with a permanent label.

Mobius Loop



China Specific Symbol



4.5.2 Lumber & Wood Packaging

Wood crates and boxes do not require a recycling mark. However, all wood materials do require treatment certification markings as defined in ISPM #15.



4.5.3 Plastic Packaging

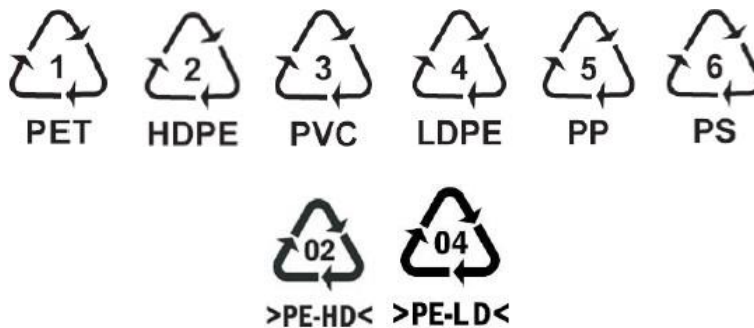









Plastic outer packages require marks and material codes that will comply with the international standards ISO 1043 and ISO 11469. Examples include:





4.6 Handling Instructions

The symbols for package handling instructions are internationally standardized in ISO R/78. The symbols must never be omitted as they are self-explanatory and so overcome language problems in international shipping.

Designation	Symbol	Explanation
Fragile, Handle with care		The symbol should be applied to easily broken cargoes. Cargoes marked with this symbol should be handled carefully and should never be tipped over or slung.
Use no hooks		Any other kind of point load should also be avoided with cargoes marked with this symbol. The symbol does not automatically prohibit the use of the plate hooks used for handling bagged cargo.
Top		The package must always be transported, handled and stored in such a way that the arrows always point upwards. Rolling, swinging, severe tipping or tumbling or other such handling must be avoided. The cargo need not, however, be stored "on top".

Keep away from heat (solar radiation)		Compliance with the symbol is best achieved if the cargo is kept under the coolest possible conditions. In any event, it must be kept away from additional sources of heat. It may be appropriate to enquire whether prevailing or anticipated temperatures may be harmful. This label should also be used for goods, such as butter and chocolate, which anybody knows should not be exposed to heat, in order to prevent losses.
Protect from heat and radioactive sources		Stowage as for the preceding symbol. The cargo must additionally be protected from radioactivity.
Slings here		The symbol indicates merely where the cargo should be slung, but not the method of lifting. If the symbols are applied equidistant from the middle or center of gravity, the package will hang level if the slings are of identical length. If this is not the case, the slinging equipment must be shortened on one side.
Keep dry		Cargoes bearing this symbol must be protected from excessive humidity and must accordingly be stored under cover. If particularly large or bulky packages cannot be stored in warehouses or sheds, they must be carefully covered with tarpaulins.
Center of gravity		This symbol is intended to provide a clear indication of the position of the center of gravity. To be meaningful, this symbol should only be used where the center of gravity is not central. The meaning is unambiguous if the symbol is applied onto two upright surfaces at right angles to each other.
No hand truck here		The absence of this symbol on packages amounts to permission to use a hand truck on them.
Stacking limitation		The maximum stacking load must be stated as "... kg max.". Since such marking is sensible only on packages with little loading capacity, cargo bearing this symbol should be stowed in the uppermost layer.
Clamp here		Stating that the package may be clamped at the indicated point is logically equivalent to a prohibition of clamping anywhere else.
Temperature limitations		According to regulations, the symbol should either be provided with the suffix "...°C" for a specific temperature or, in the case of a temperature range, with an upper ("...°C max.") and lower ("...°C min.") temperature limit. The corresponding temperatures or temperature limits should also be noted on the consignment note.
Do not use forklift truck here		This symbol should only be applied to the sides where the forklift truck cannot be used. Absence of the symbol on other sides of the package amounts to permission to use forklift trucks on these sides.
Electrostatic sensitive device		Contact with packages bearing this symbol should be avoided at low levels of relative humidity, especially if insulating footwear is being worn or the ground/floor is nonconductive. Low levels of relative humidity must in particular be expected on hot, dry summer days and very cold winter days.

Do not destroy barrier		A barrier layer which is (virtually) impermeable to water vapor and contains desiccants for corrosion protection is located beneath the outer packaging. This protection will be ineffective if the barrier layer is damaged. Since the symbol has not yet been approved by the ISO, puncturing of the outer shell must in particular be avoided for any packages bearing the words "Packed with desiccants".
Tear off here		This symbol is intended only for the receiver.

5 Regulatory and Environmental Requirements

All packages and packaging material utilized for AGCO NA parts must be in full compliance with all legal and environmental regulations and requirements for all AGCO NA sites where parts are distributed. All shipping containers which contain material that is a dangerous article as described in Department of Transportation Regulations and Transportation of Hazardous Materials must have the prescribed special label conspicuously applied on the same panel to which the shipping label is applied.

5.1 Regulatory Requirements

5.1.1 Hazardous Material and Dangerous Goods

Hazardous Materials (HM) – A term commonly used inside the United States to describe substances or articles with the potential to impact human health and or the environment. These materials exhibit harmful characteristics and can be:

- Corrosive
- Flammable
- Explosive
- Reactive

Dangerous Good (DG) – A term commonly used outside of the United States to describe substances or articles with the potential to impact human health and or the environment. These materials exhibit harmful characteristics and can be:

- Corrosive
- Flammable
- Explosive
- Reactive

5.1.2 Material Safety Data Sheet (MSDS)

MSDS is a mandatory document that must be provided in English. It is used to communicate hazards to people coming in contact with the material. The document includes material, emergency-response, and regulatory information in a format prescribed by domestic and international regulation. When shipping chemicals and materials that present potential health hazards to AGCO NA sites, one copy of the MSDS in a pouch on the outside of the package and one copy inside the package with the part is required.

5.2 Restricted Materials

Packaging materials should avoid the use of the following substances:

1. Lead
2. Mercury
3. Cadmium
4. Hexavalent chromium
5. Polybrominated biphenyls (PBB)
6. Polybrominated dipenylether (PBDE)

6 Packaging Proposals and Approval

The packaging proposal must be submitted to AGCO Logistics Packaging Department AGCONAPackaging@AGCOcorp.com during the development phase.

Suppliers are required to complete the “**AGCO NA Packaging Data Sheet**” available on <http://www.agcocorp.com/suppliers/materials-management.html>.

Direct link to access the “**AGCO NA Packaging Data Sheet**” (template and sample):
http://www.agcocorp.com/content/dam/agcocorp/Suppliers/AGCO%20NA%20Template_Logistics%20Data%20Sheet.xlsx